

NOTES:

- 1.HUOSING: PA9T HIGH-TEMP THERMOPLASTIC UL94V-0 COLOR:CREAM-COLOURED
- 2.TERMINAL:PHOSPHOR BRONZE
PLATING:1*”GOLD FLASH OVERALL 50~100*”NICKEL UNDER PLATED.

Ordering information

BTB $\frac{3}{2}$ $\frac{08}{08}$ - XX - $\frac{1}{40-40P}$ $\frac{52}{15-15P}$ W GO W $\frac{1}{1PBT}$ $\frac{5}{2PA46}$ $\frac{4}{3PA8T}$

1. Male
2. Female

Pitch:
1. 06:0.5mm
2. 08:0.8mm

No. of PIN:
(8~100P)
40~40P
15~15P

Combined High:
15:1.5mm
20:2.0mm
25:2.5mm
30:3.0mm
35:3.5mm
40:4.0mm
45:4.5mm
50:5.0mm
60:6.0mm

Welding:
S:180°
R:90°
W:SMT
W:90° SMT

Contact Plating:
G0:gold flash
G1:3U"
G2:5U"
G3:10U"

Plastic Material:
1:PBT
2:PA46
3:PA6T
4:PA9T
5:LCP

Packing:
1:bag
2:Tube
3:Box
4:Reel

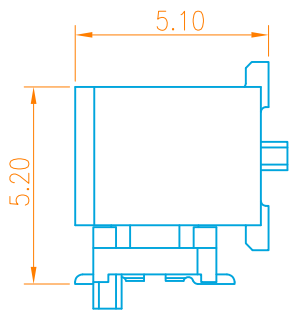
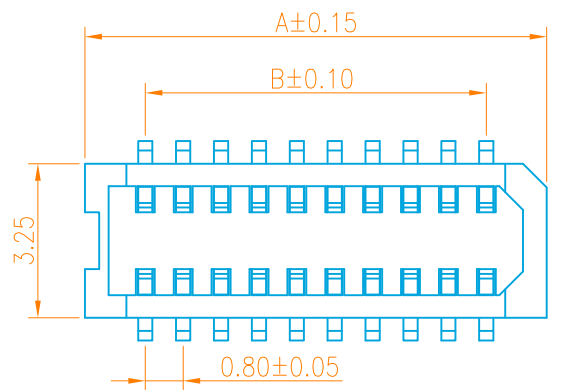

MATING HEIGHT
SCALE:1.25:1

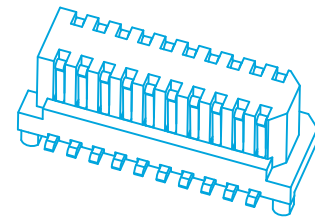
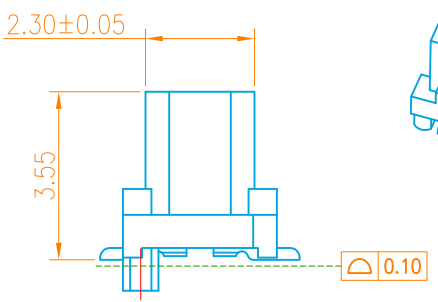
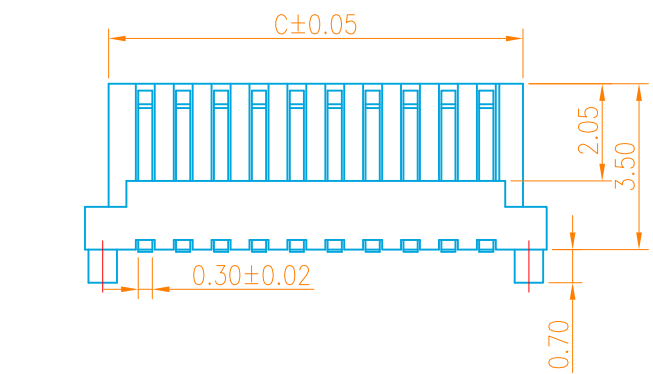

3D VIEW

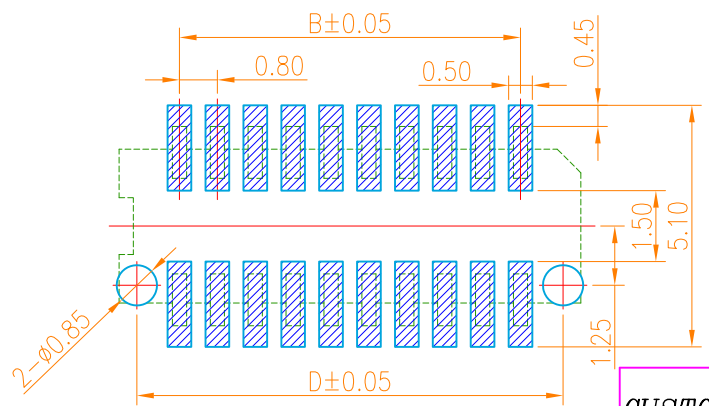
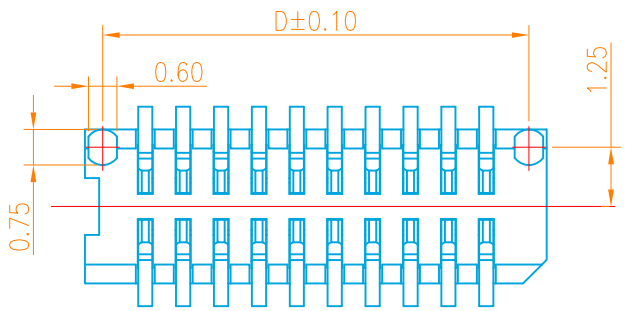

RECOMMENDED PCB PATTERN DIM.
TOLERANCE : ±0.05

NO. of contacts	Dimensions			
	A.	B.	C.	D.
4	3.35	0.80	2.35	2.60
6	4.15	1.60	3.15	3.40
8	4.95	2.40	3.95	4.20
10	5.75	3.20	4.75	5.00
12	6.55	4.00	5.55	5.80
14	7.35	4.80	6.35	6.60
16	8.15	5.60	7.15	7.40
18	8.95	6.40	7.95	8.20
20	9.75	7.20	8.75	9.00
22	10.55	8.00	9.55	9.80
24	11.35	8.80	10.35	10.60
26	12.15	9.60	11.15	11.40
28	12.95	10.40	11.95	12.20
30	13.75	11.20	12.75	13.00
32	14.55	12.00	13.55	13.80
34	15.35	12.80	14.35	14.60
36	16.15	13.60	15.15	15.40
38	16.95	14.40	15.95	16.20
40	17.75	15.20	16.75	17.00
42	18.55	16.00	17.55	17.80
44	19.35	16.80	18.35	18.60
46	20.15	17.60	19.15	19.40
48	20.95	18.40	19.95	20.20
50	21.75	19.20	20.75	21.00
52	22.55	20.00	21.55	21.80

CUSTOMER



一般公差 GENERAL TOLERANCE .X ±0.25 .XX ±0.15 .XXX ±0.05 ANGLES ±1°	Kevin 2016.07.05	品名(TITLE): BTB 0.8 2*NP SMT 侧插公座
修订 SER	修改摘要 REVISION DESCRIPTION	料号(PART NO): 3108-XX152RGOW134
版本 (REV) A	日期 DATE	比例(SCALE) 1:8
核准 (APPD):	张数(SHEET) 1 OF 1	单位(UNITS) mm
		图幅(SIZE) A4



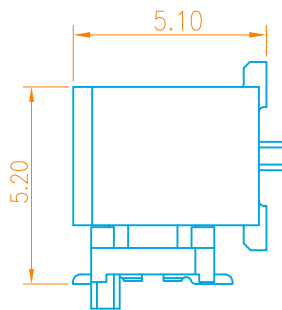
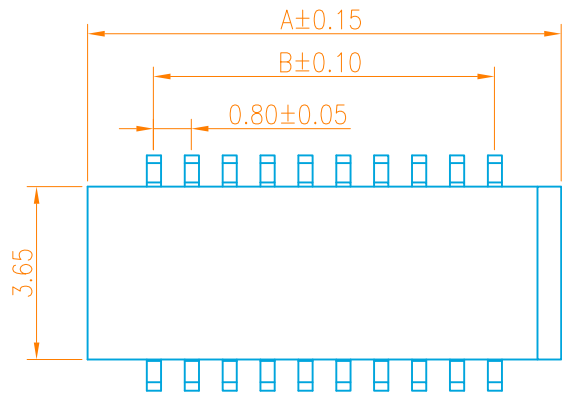

MATING HEIGHT
SCALE:1.25:1

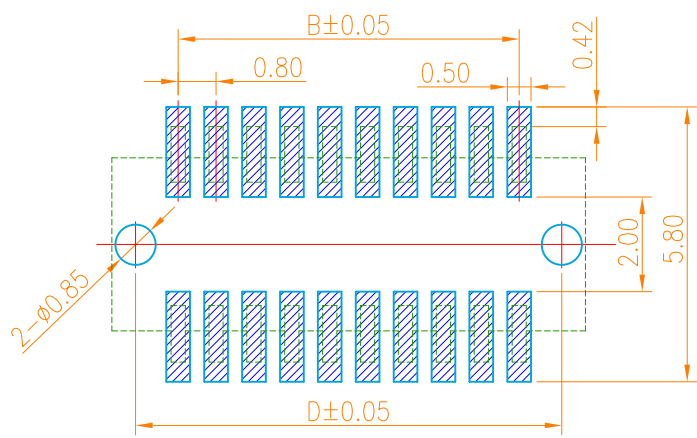
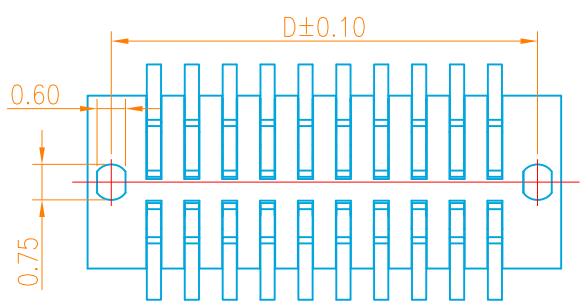
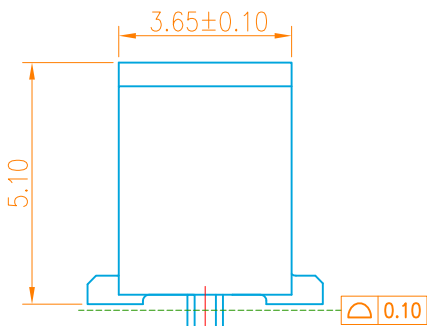
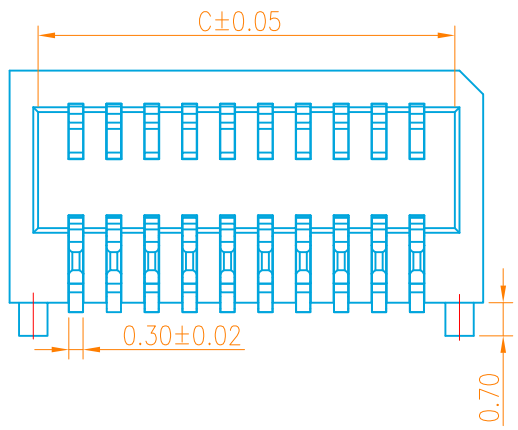

RECOMMENDED PCB PATTERN DIM.
TOLERANCE : ±0.05

NOTES:

- 1.HUOSING: PA9T HIGH-TEMP THERMOPLASTIC UL94V-0 COLOR:CREAM-COLOURED
- 2.TERMINAL:PHOSPHOR BRONZE
PLATING:1*”GOLD FLASH OVERALL 50~100*”NICKEL UNDER PLATED.

Ordering information

BTB- 3 2 08- XX - 1 52 W GO W 1 5 4

1. Male Pitch: 1.06:0.5mm 2.08:0.8mm
2. Female

No. of PIN: (8-100P) 40-40P 15-15P

Combined High: 15:1.5mm 20:2.0mm 25:2.5mm 30:3.0mm 35:3.5mm 40:4.0mm 45:4.5mm 50:5.0mm 60:6.0mm

Welding: S:180° R:90° W:SMT W:90° SMT

Contact Plating: G0:gold flash G1:3U" G2:5U" G3:10U"

Plastic Material: 1:PBT 2:PA66 3:PA6T 4:PA9T 5:LCP

Packing: 1:bag 2:Tube 3:Box 4:Reel

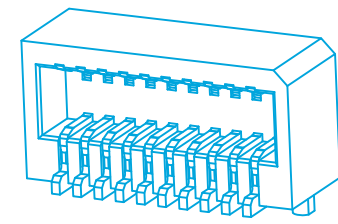

3D VIEW

NO. of contacts	Dimensions			
	A.	B.	C.	D.
4	3.60	0.80	2.40	2.60
6	4.40	1.60	3.20	3.40
8	5.20	2.40	4.00	4.20
10	6.00	3.20	4.80	5.00
12	6.80	4.00	5.60	5.80
14	7.60	4.80	6.40	6.60
16	8.40	5.60	7.20	7.40
18	9.20	6.40	8.00	8.20
20	10.00	7.20	8.80	9.00
22	10.80	8.00	9.60	9.80
24	11.60	8.80	10.40	10.60
26	12.40	9.60	11.20	11.40
28	13.20	10.40	12.00	12.20
30	14.00	11.20	12.80	13.00
32	14.80	12.00	13.60	13.80
34	15.60	12.80	14.40	14.60
36	16.40	13.60	15.20	15.40
38	17.20	14.40	16.00	16.20
40	18.00	15.20	16.80	17.00
42	18.80	16.00	17.60	17.80
44	19.60	16.80	18.40	18.60
46	20.40	17.60	19.20	19.40
48	21.20	18.40	20.00	20.20
50	22.00	19.20	20.80	21.00
52	22.80	20.00	21.60	21.80



CUSTOMER													
一般公差 GENERAL TOLERANCE .X ±0.25 .XX ±0.15 .XXX ±0.05 ANGLES ±1°						制图 (DR): Kavin 2016.07.05	品名(TITLE): BTB 0.8 2*NP SMT 侧插母座						
修订 SER		修改摘要 REVISION DESCRIPTION		签名 SIGNATURE		日期 DATE		版本 (REV) A		审核 (CHKD): 		料号 (PART NO): 3208-XX152RGOW134	
						比例 (SCALE) 1:8		单位 (UNITS) mm		张数 (SHEET) 1 OF 1		图幅 (SIZE) A4	
						核准 (APPD):							